

Faire simple, la clé de la durabilité ?

Bertrand Delacrétaz

Principal Scientist, Adobe
Former Board Member, Apache Software Foundation

@bdelacretaz@fosstodon.org
grep.codeconsult.ch

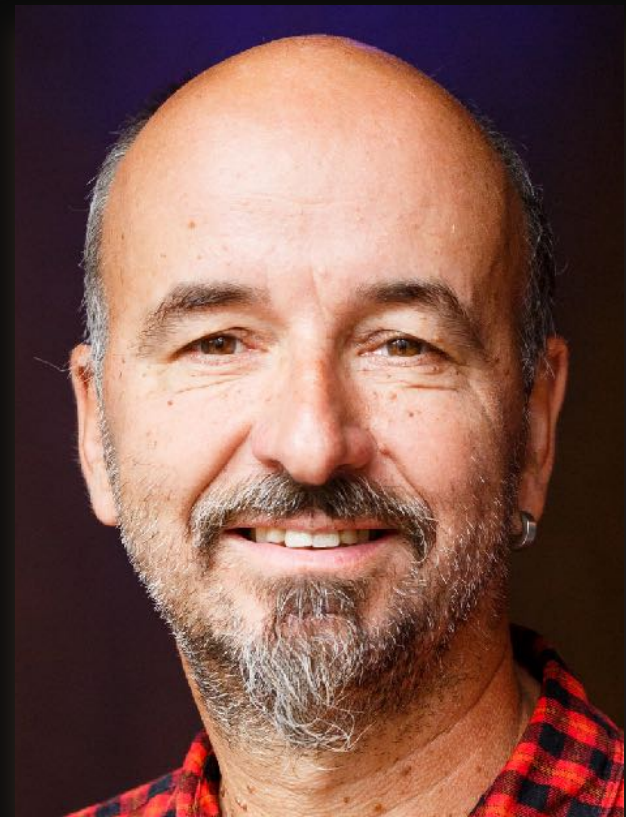

*images: Adobe Stock, sauf indication contraire
revision 2024-04-16B*

3
parties

Simplicité et beauté ...

Exemples

Comment faire ?

1

Simplicité et beauté ...

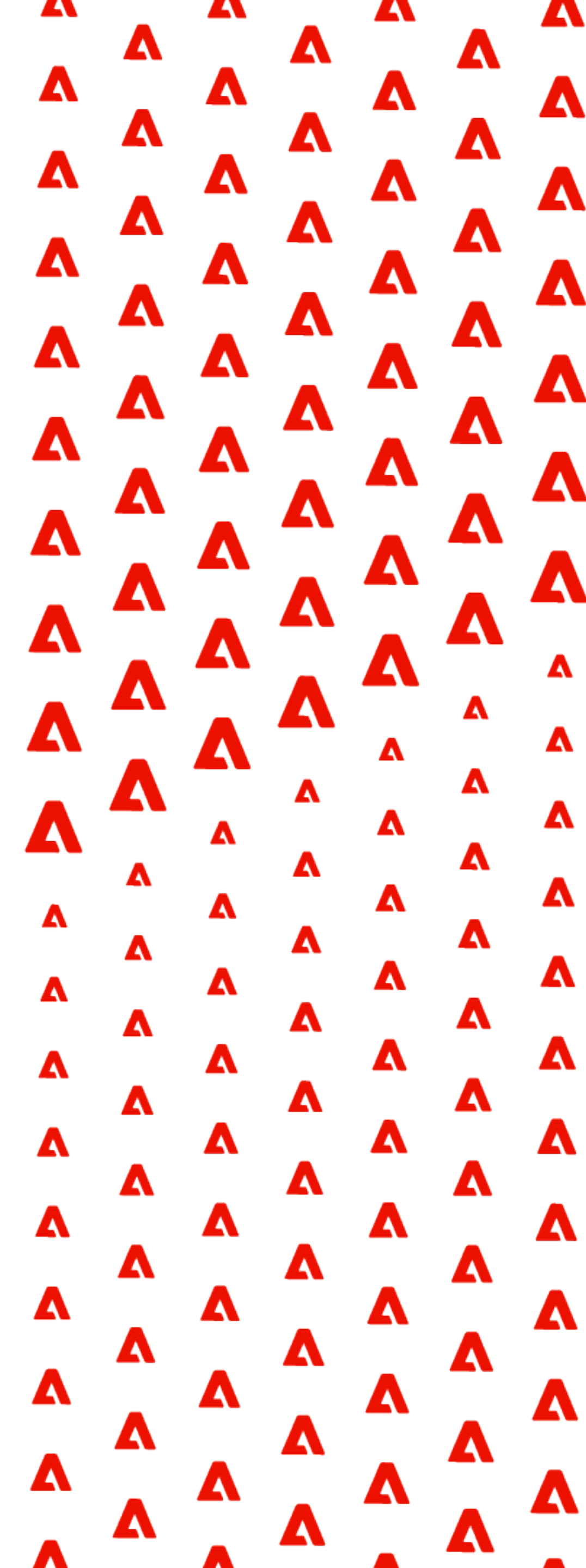



Simplicité
splendide et évidente

Rien à retrancher?





**Le kazoo,
minimaliste
mais efficace**

Simple, mais pas simpliste...



1930

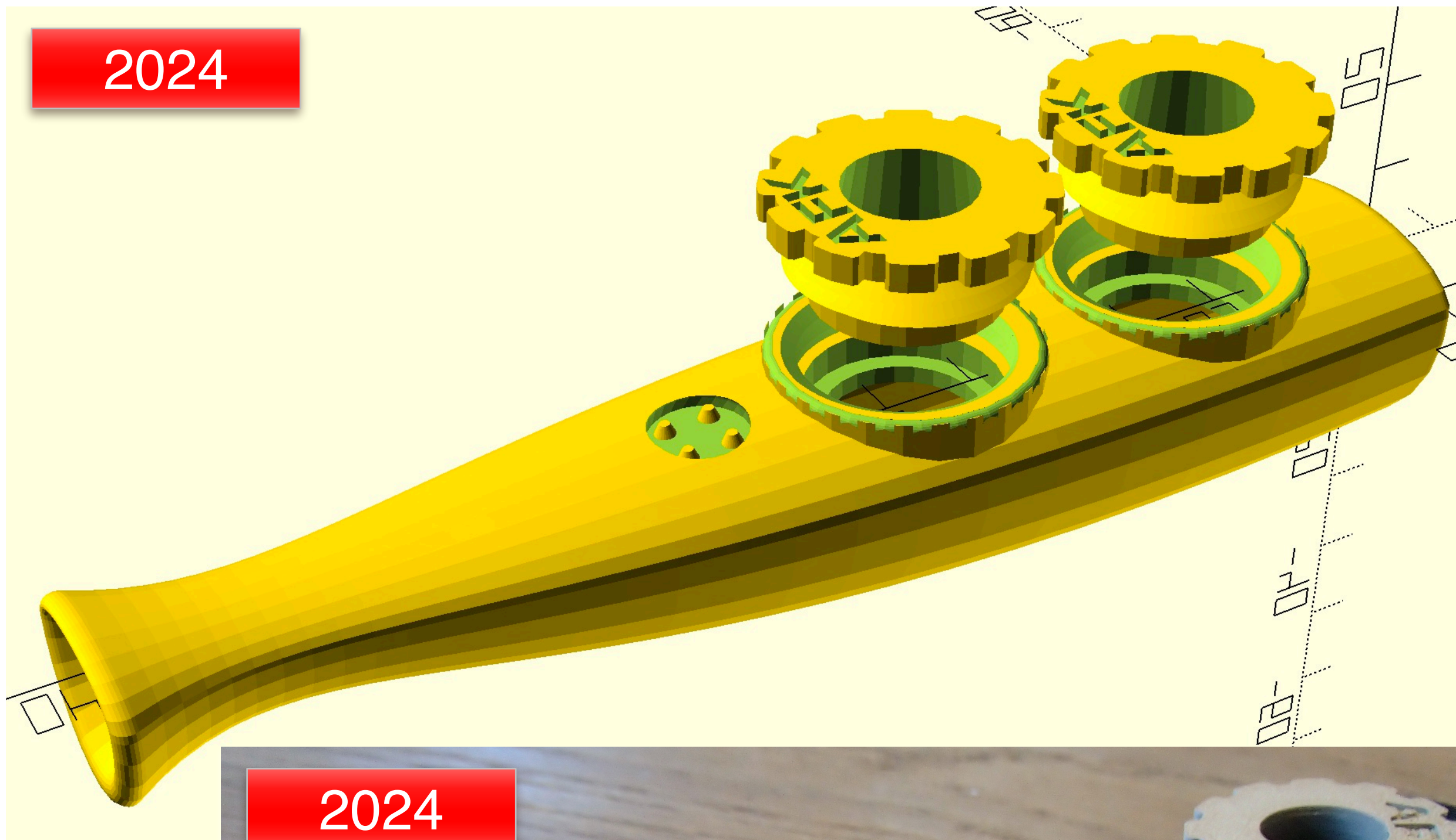

2024

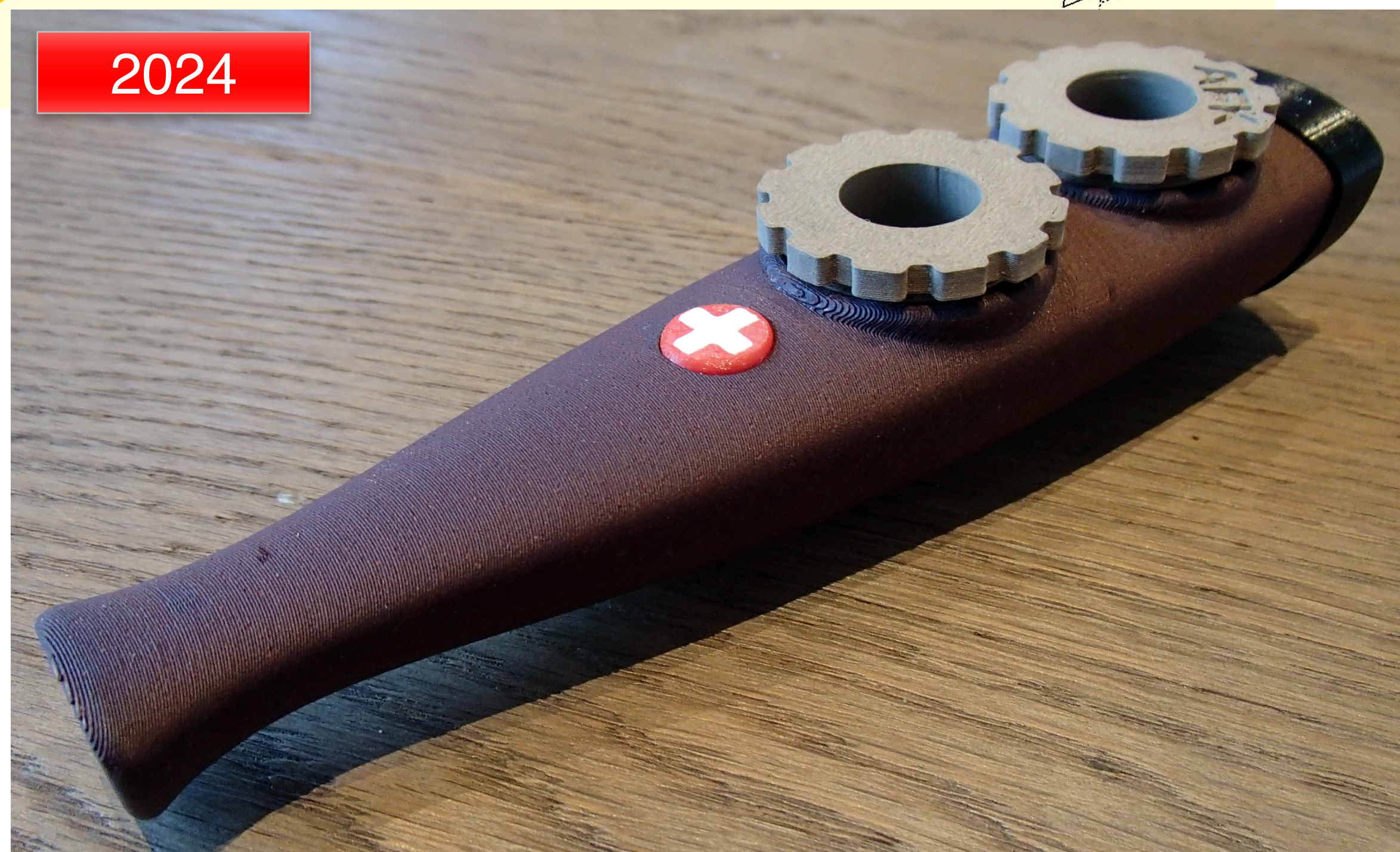

2024

kazoo 2024: Bertrand Delacrétaz

Simple, mais pas simpliste!

SPACE & PHYSICS

Fact or Fiction?: NASA Spent Millions to Develop a Pen that Would Write in Space, whereas the Soviet Cosmonauts Used a Pencil

**SCIENTIFIC
AMERICAN**

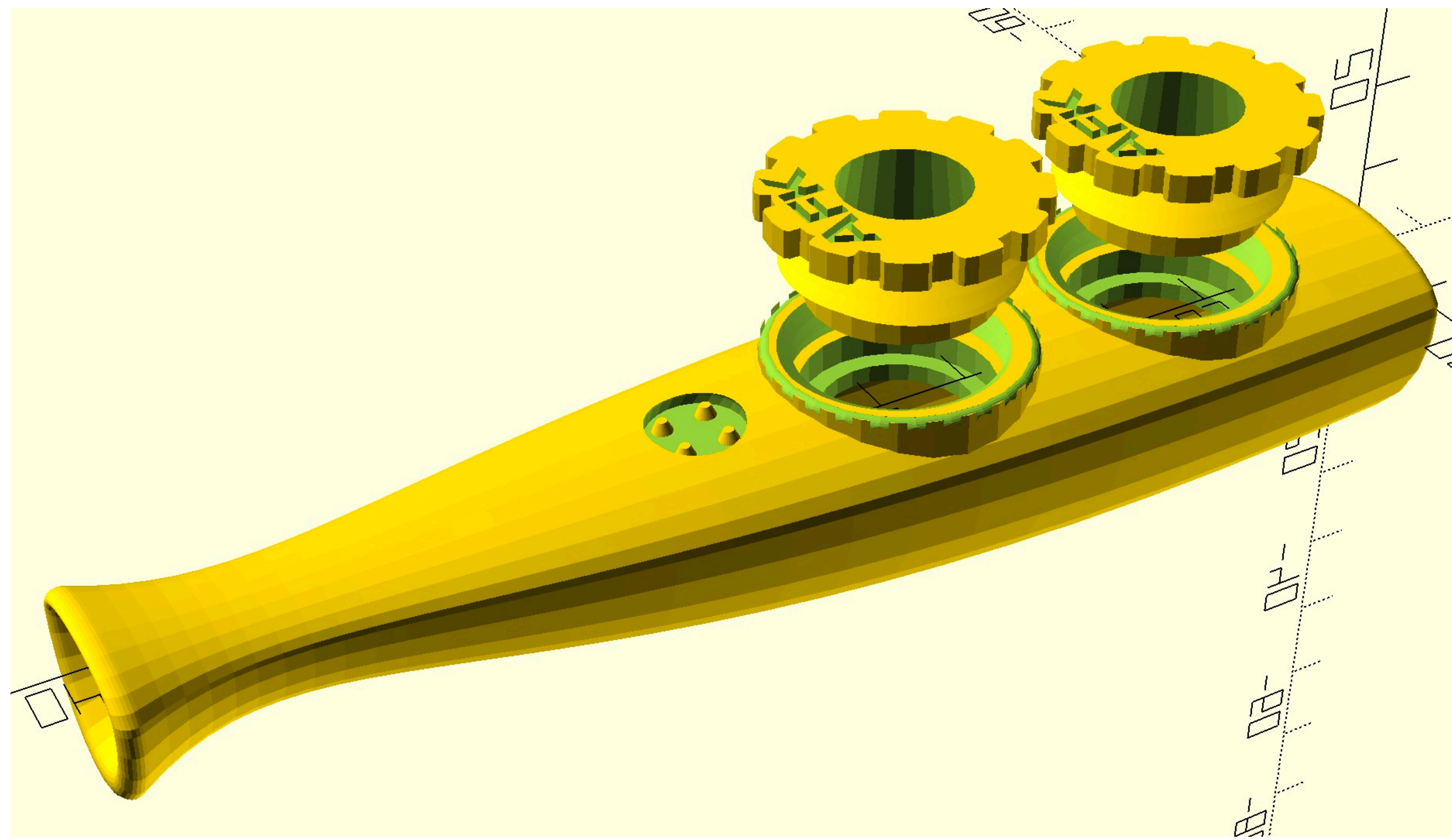

simplicité splendide, adaptée et efficace

2

Exemples

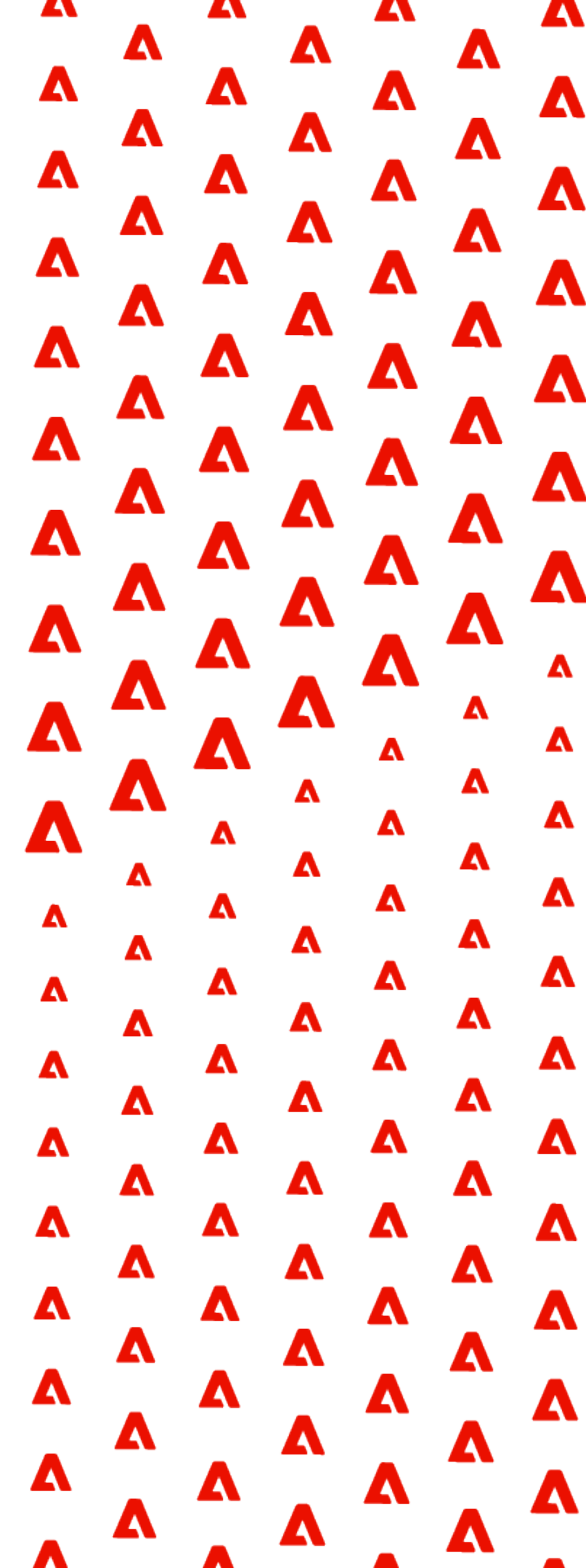

Acquisition continue de données météo?



Plusieurs centaines de stations

données continues

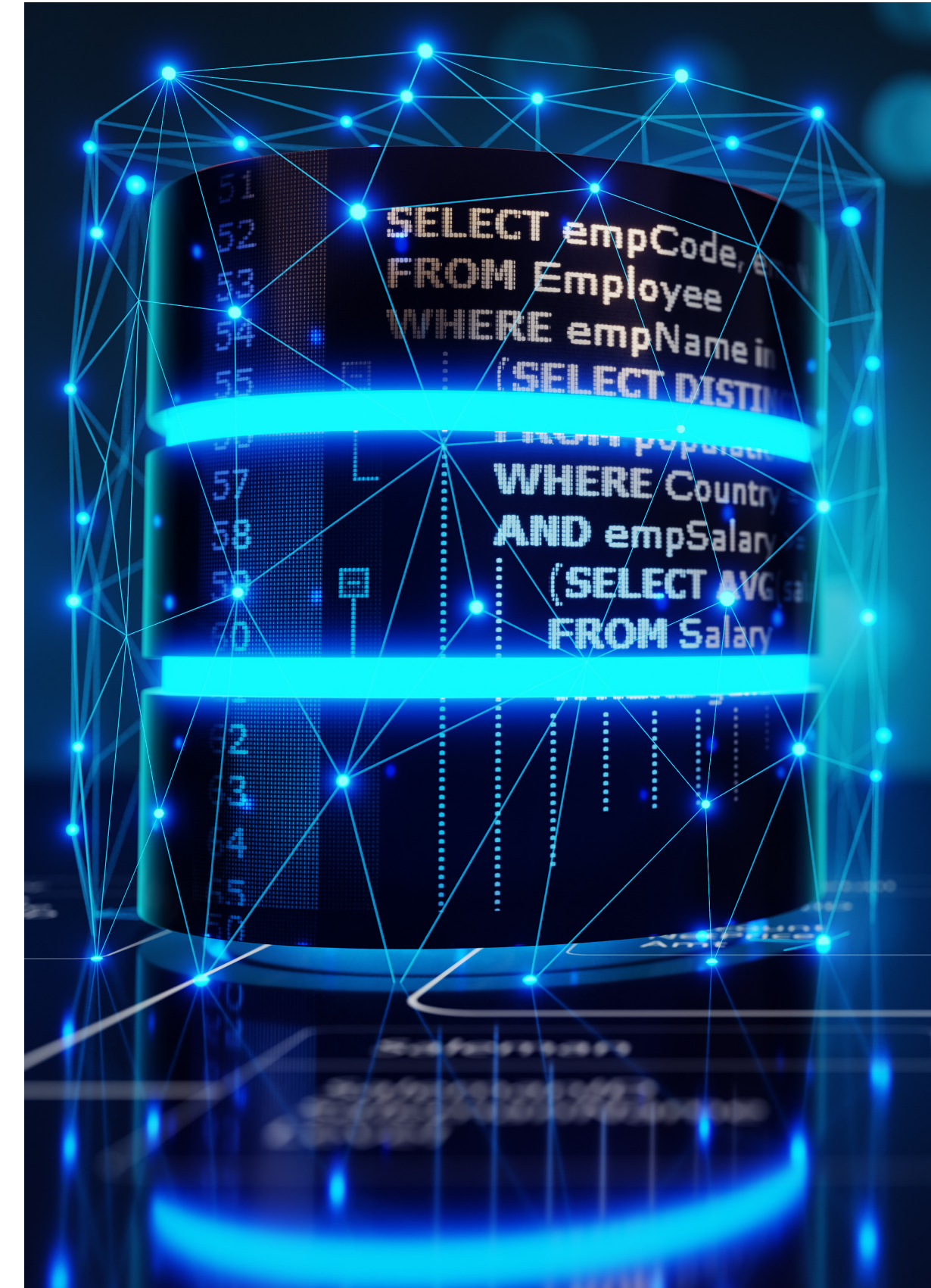
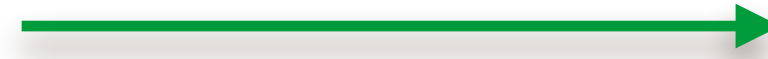

Stockage et requêtes simples?

Acquisition continue de données météo!



Plusieurs centaines de stations

continuous data

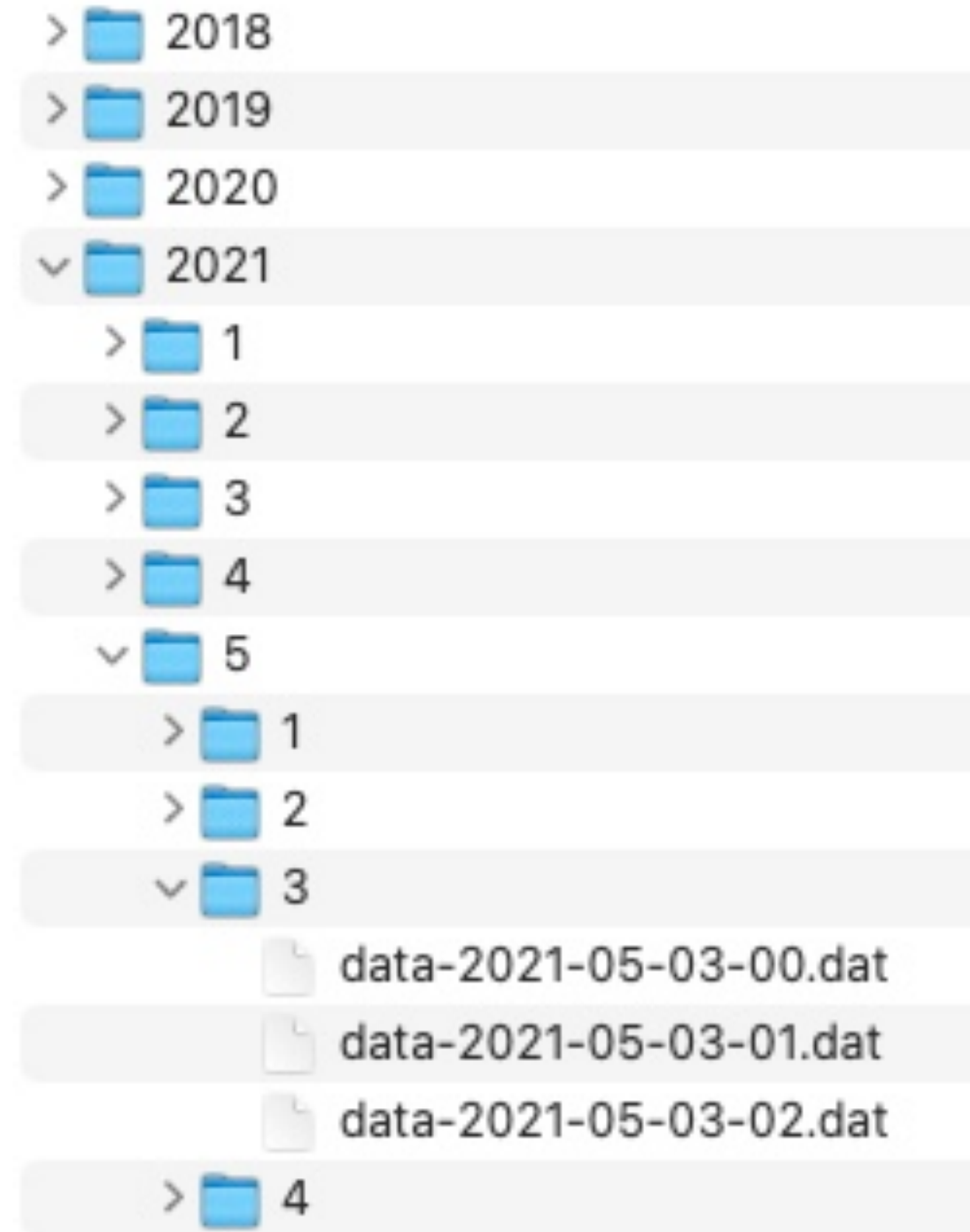

Stockage et requêtes simples:
Fichiers dans des dossiers chronologiques

Enregistrement audio numérique robuste?

C'était en 1999...



enregistrement audio continu
impossible de perdre > 15 secondes

Enregistrement audio numérique robuste??

Complexe ?

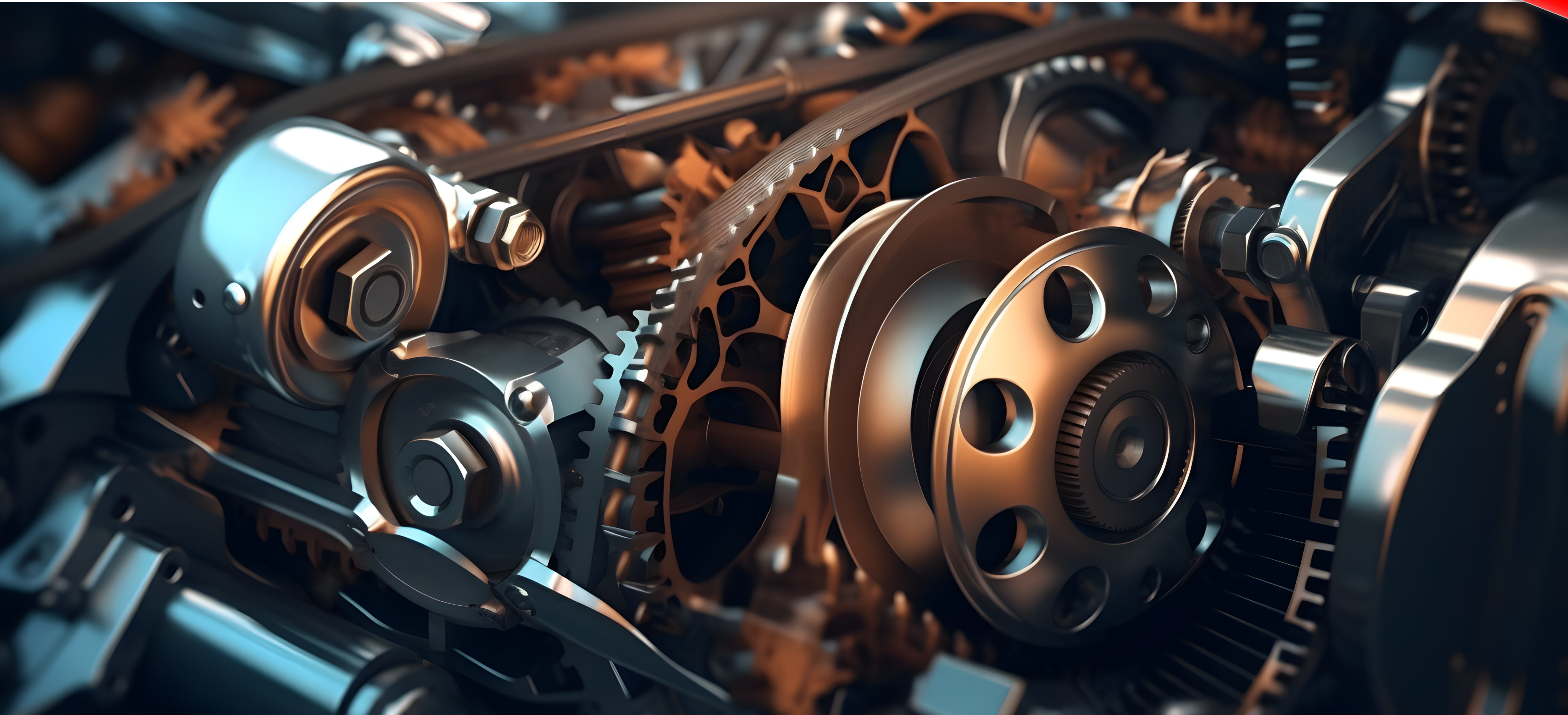

Enregistrement audio numérique robuste!

86 lignes de code - 3 mois de travail

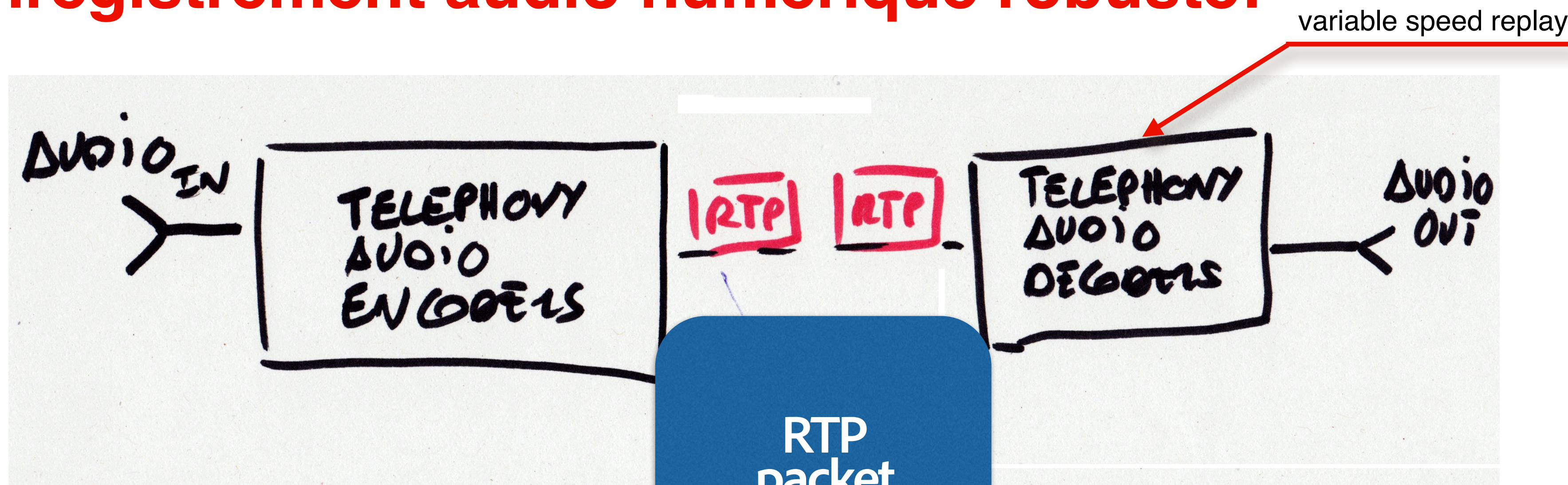

```
s = UDP socket
While(s is open) {
  Wait for packet
  Packet matches our filter?
  If yes:
    Compute storage path from T
    Append packet to storage file
}
```

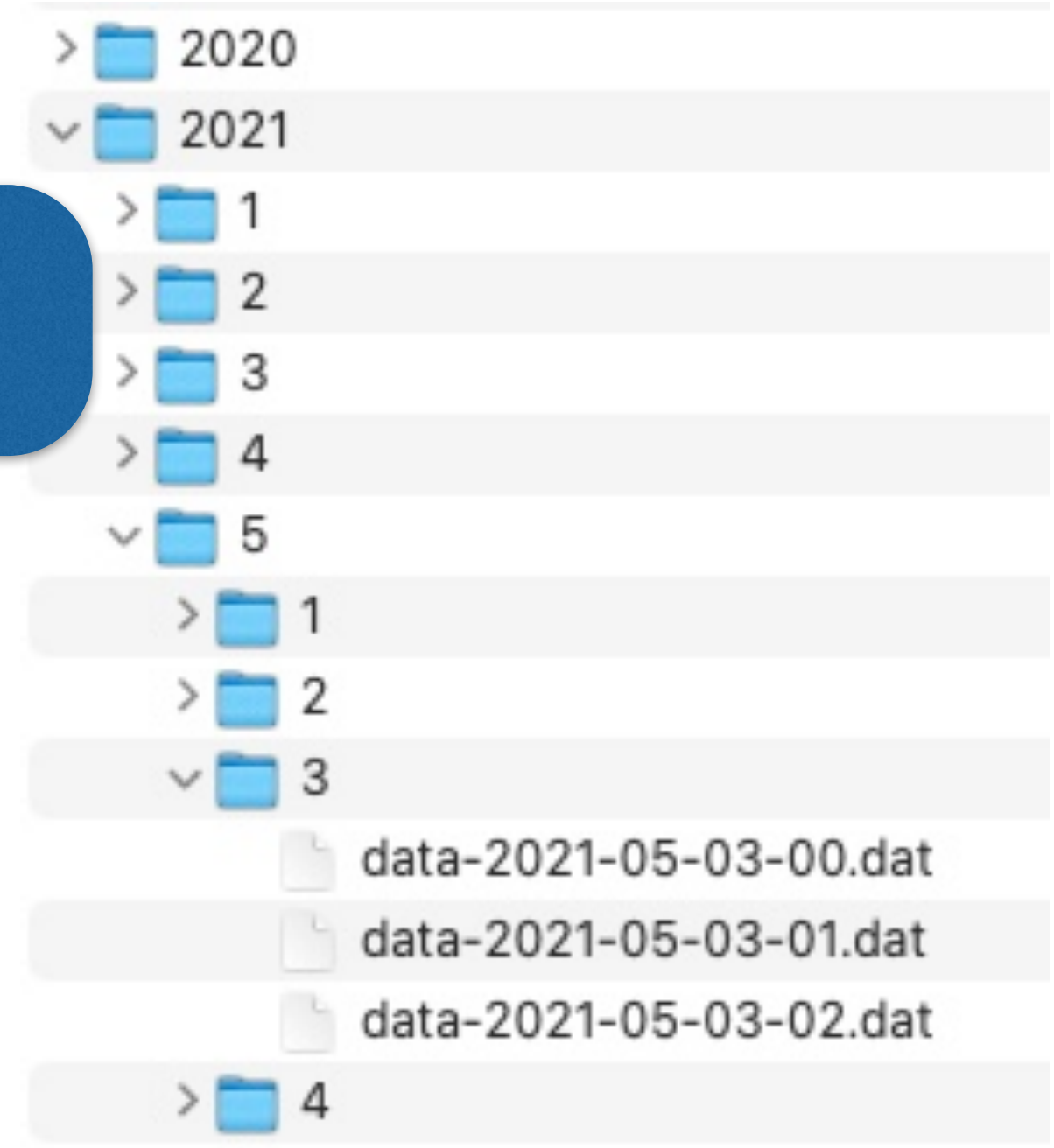

Apache Sling Servlets

```
@Component(service = { Servlet.class })
@SlingServletResourceTypes(
    resourceTypes="/apps/my/type",
    methods= "GET",
    extensions="html",
    selectors="hello")
public class MyServlet extends SlingSafeMethodsServlet {

    @Override
    protected void doGet(SlingHttpServletRequest request, SlingHttpServletResponse response)
        ...
}
}
```









Module de traitement de requêtes HTTP "câblé" sur une méthode de requête, une extension, un type de resource.

Simple, clair, familier.

Web Components pour une page de commerce?

<https://opensource.adobe.com/web-platform-zoo>









Cart: 7 products, 38 items, USD 540 - [Cart contents](#)

 <p>Blue bottle</p> <p>+ 3 -</p> <p>USD 17: 3 in cart → USD 51</p> <p><i>This one is really blue</i></p>	 <p>Symmetric knife</p> <p>+ 11 -</p> <p>USD 21: 11 in cart → USD 231</p> <p><i>Not really, it's just marketing</i></p>	 <p>Fantastic bottle</p> <p>+ 4 -</p> <p>USD 19: 4 in cart → USD 76</p> <p><i>This bottle is really fantastic</i></p>	 <p>Super bread knife</p> <p>+ 0 -</p> <p>USD 8: 0 in cart → USD 0</p> <p><i>Stainless steel, the works!</i></p>
 <p>East white</p> <p>+ 11 -</p> <p>USD 5: 11 in cart → USD 55</p> <p><i>Eastern is bestern</i></p>	 <p>Soft South Red</p> <p>+ 5 -</p> <p>USD 15: 5 in cart → USD 75</p> <p><i>Soft but not weak!</i></p>	 <p>Kitchen knife</p> <p>+ 2 -</p> <p>USD 10: 2 in cart → USD 20</p> <p><i>A must for every kitchen</i></p>	 <p>White from the South</p> <p>+ 0 -</p> <p>USD 6: 0 in cart → USD 0</p>

Web Components pour une page de commerce??

<https://opensource.adobe.com/web-platform-zoo>

STATUS Cart: 7 products, 38 items, USD 540 - [Cart contents](#)

IMAGE	PRODUCT	TITLE	SLIDER	PRICE	TEXT		
				Blue bottle	Symmetric knife	Fantastic bottle	Super bread knife
				+ 3 -	+ 11 -	+ 4 -	+ 0 -
				USD 17: 3 in cart → USD 51	USD 21: 11 in cart → USD 231	USD 19: 4 in cart → USD 76	USD 8: 0 in cart → USD 0
				<i>This one is really blue</i>	<i>Not really, it's just marketing</i>	<i>This bottle is really fantastic</i>	<i>Stainless steel, the works!</i>
				East white	Soft South Red	Kitchen knife	White from the South
				+ 11 -	+ 5 -	+ 2 -	+ 0 -
				USD 5: 11 in cart → USD 55	USD 15: 5 in cart → USD 75	USD 10: 2 in cart → USD 20	USD 6: 0 in cart → USD 0
				<i>Eastern is bestern</i>	<i>Soft but not weak!</i>	<i>A must for every kitchen</i>	

PRODUCT LIST









Web Components pour une page de commerce!

<https://opensource.adobe.com/web-platform-zoo>

STATUS Cart: 7 products, 38 items, USD 540 - [Cart contents](#)

HTML TEMPLATE

INC-DEC

 Blue bottle + 3 - USD 17: 3 in cart → USD 51 <i>This one is really blue</i>	 Symmetric knife + 11 - USD 21: 11 in cart → USD 231 <i>Not really, it's just marketing</i>	 Fantastic bottle + 4 - USD 19: 4 in cart → USD 76 <i>This bottle is really fantastic</i>	 Super bread knife + 0 - USD 8: 0 in cart → USD 0 <i>Stainless steel, the works!</i>
 East white + 11 - USD 5: 11 in cart → USD 55 <i>Eastern is bestern</i>	 Soft South Red + 5 - USD 15: 5 in cart → USD 75 <i>Soft but not weak!</i>	 Kitchen knife + 2 - USD 10: 2 in cart → USD 20 <i>A must for every kitchen</i>	 White from the South + 0 - USD 6: 0 in cart → USD 0

PRODUCT LIST

AI 1Y STATUS
(INVISIBLE)

simple, mais pas simpliste!

3

Comment faire?

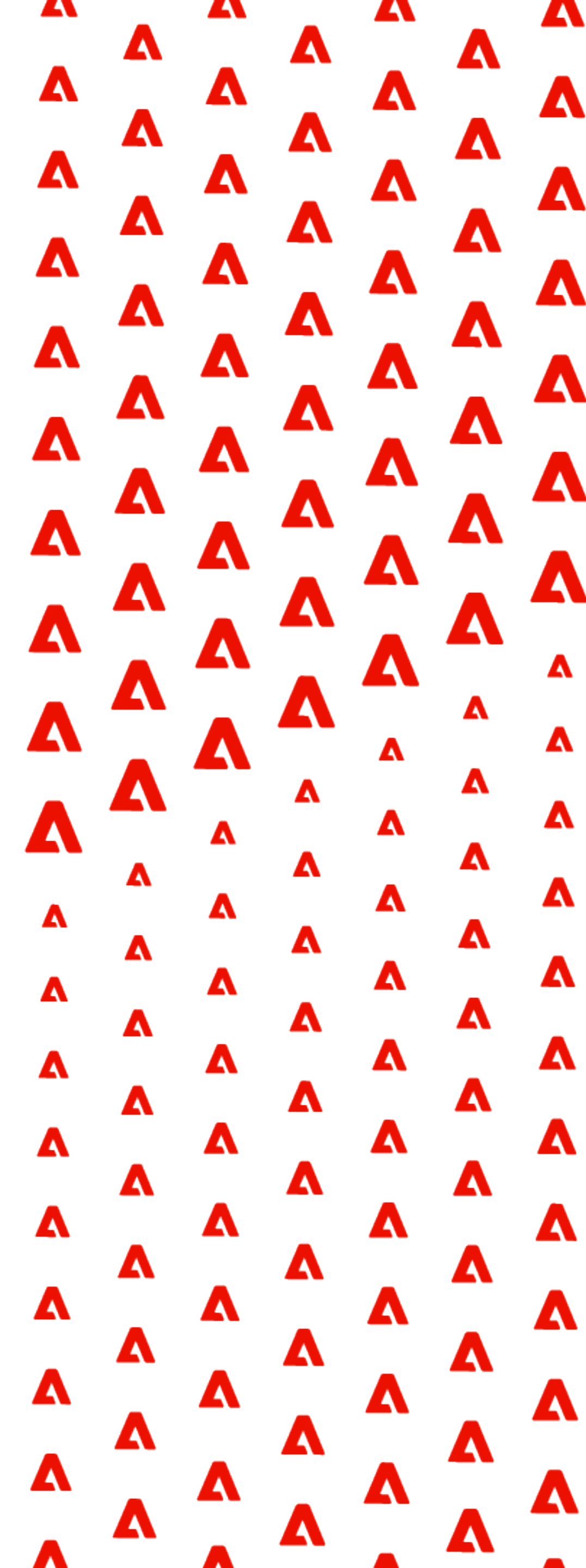



La simplicité
au centre..

La *quête* de simplicité..



N'abandonnez pas - essayez encore!



Mesurer, évaluer



Il semble que la perfection soit atteinte non quand il n'y a plus rien à ajouter, mais quand il n'y a plus rien à retrancher.

Antoine de Saint-Exupéry

Définition d'achèvement ("of done")



Reste-t-il
quelque chose à
retrancher?



Simplicité
splendide et évidente

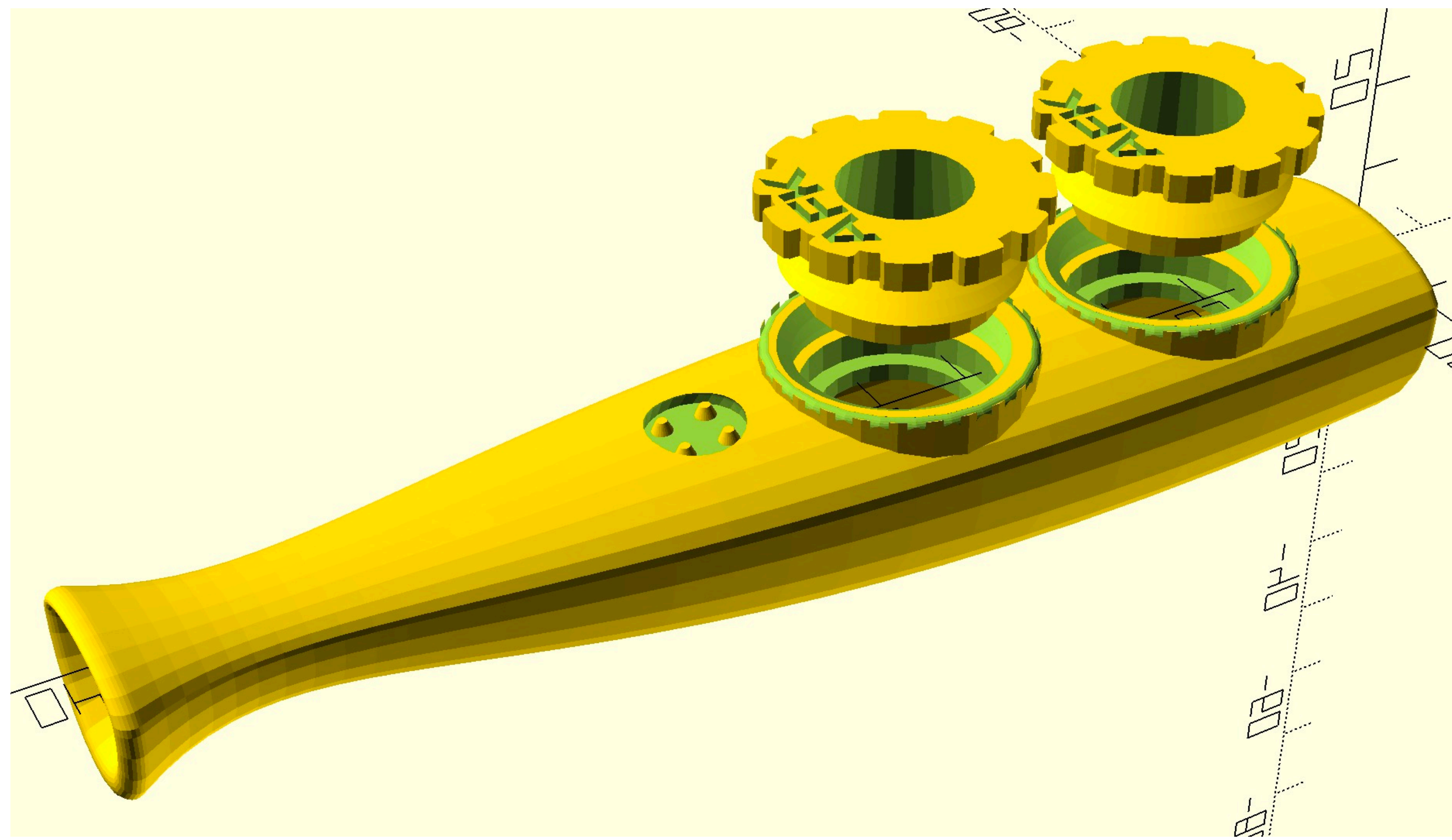

Simple, mais pas simpliste

4

Coda

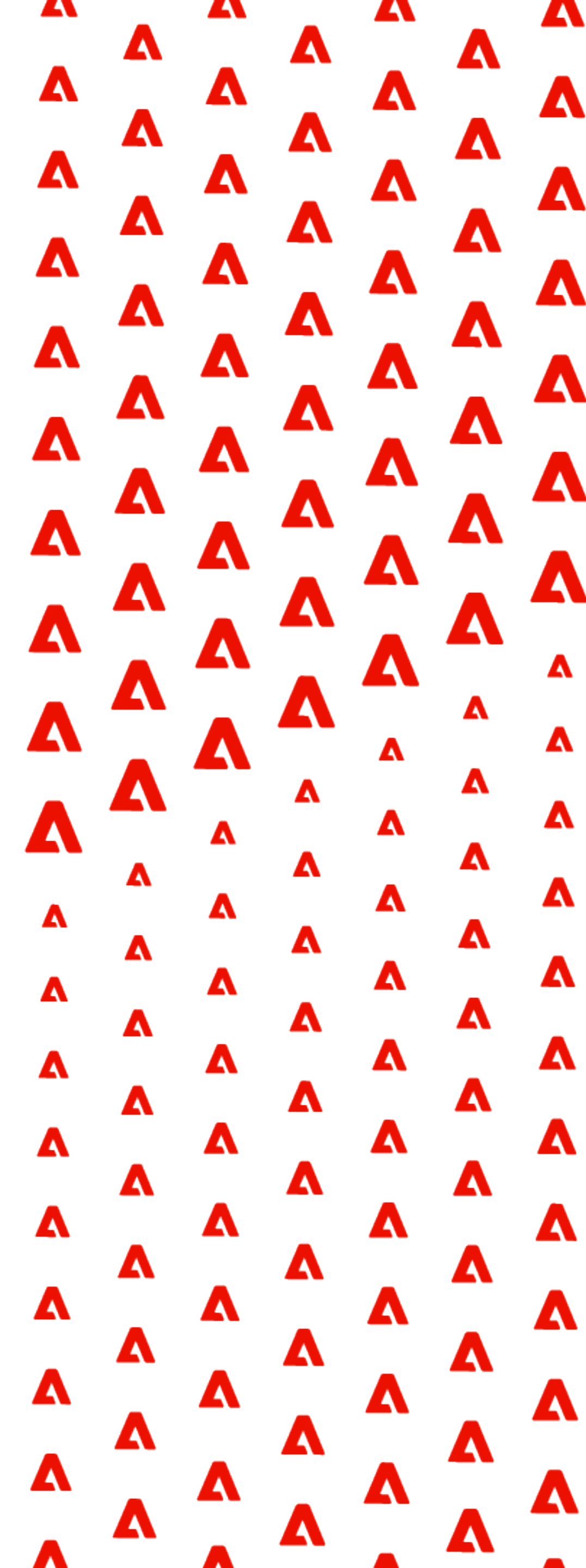

LA SIMPLICITÉ? IMPORTANTE, DIFFICILE, INTÉGRABLE!

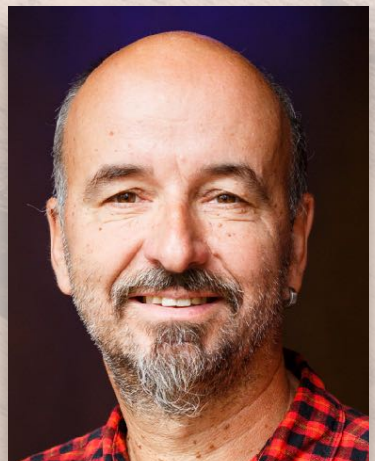
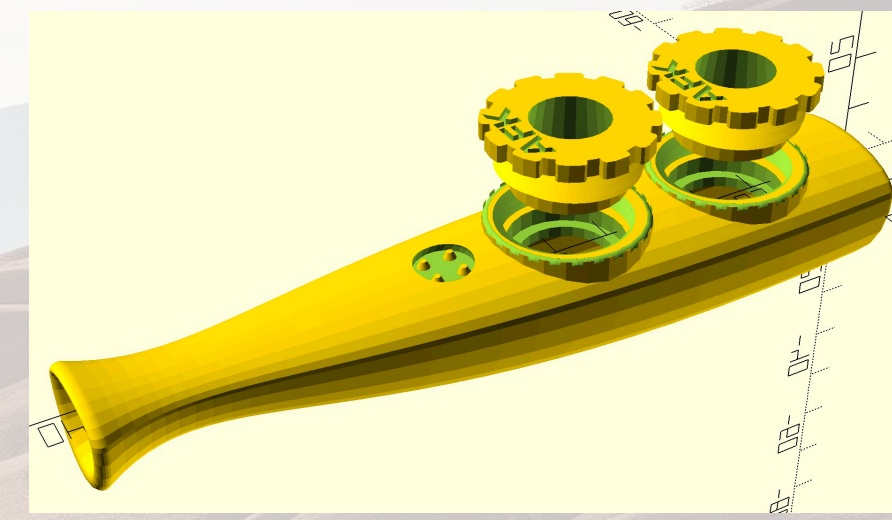

Bertrand Delacrétaz
fosstodon.org/@bdelacretaz
grep.codeconsult.ch/

